

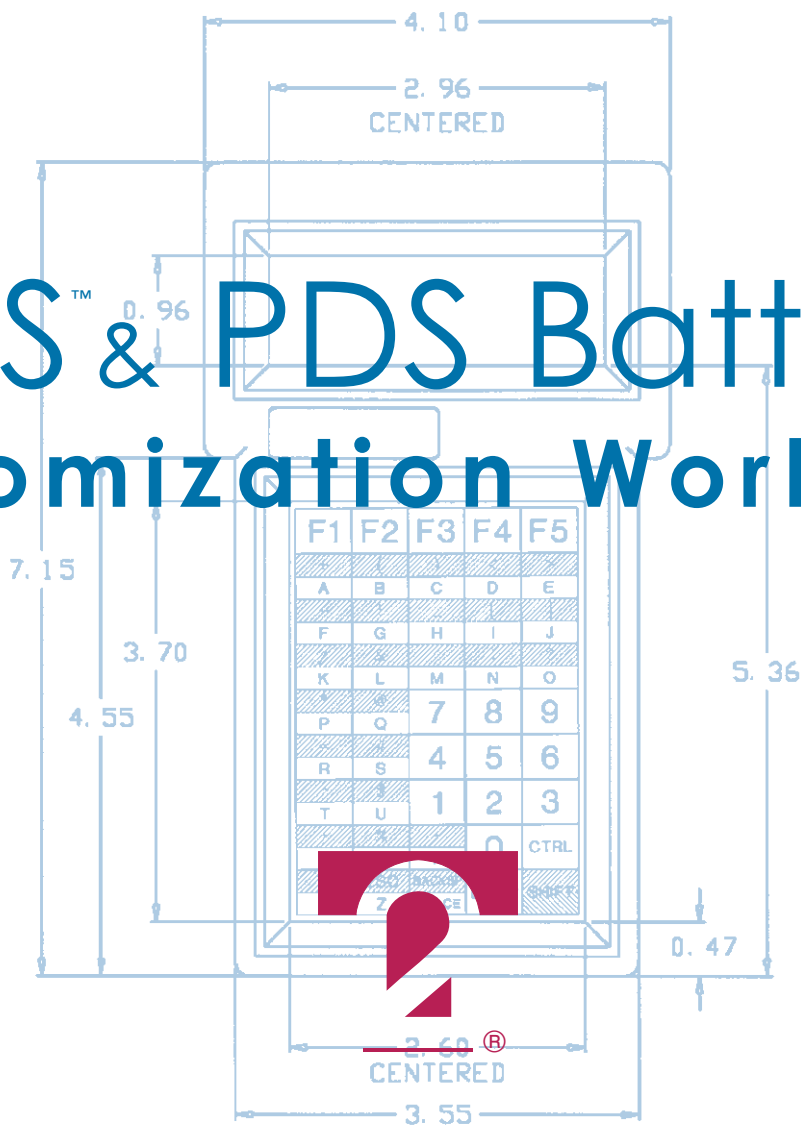

# PDS™ & PDS Battery™ Customization Workbook

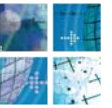



Thank you for downloading the customization booklet for the PDS™. Our objective is to supply you with the highest quality hand held computer products available—with all the custom features required for your unique application.

This workbook provides easy-to-use templates to customize the PDS for your application. To get started, just fill in your name and contact information and let the customization begin! If you have questions, just give us a call at 215.441.5305 and ask for Customer Service. No question is too simple when it comes to creating your masterpiece.

If you will not be providing camera-ready artwork, please sketch in the desired graphics and return the appropriate sheets indicating the particular items to be customized. Two Technologies uses the Pantone Matching System® Colors (uncoated colors only) to match all colors. Pantone® color guides are available at virtually any art supply store, or our customer service team can help you in selecting colors that best match your product or corporate colors.

The following features are customizable on the PDS:

- Case Color
- Logo Tag
- Keypad
- On/Off Switch (Battery powered only)
- Cables (Line powered only)
- Serial Tag

We look forward to the opportunity to work with you on this project. Rest assured, we will provide you with a hand held computer you are proud to put your name on.

---

**Name:**

**Title:**

**Company:**

**Telephone Number:**

**E-Mail Address:**

# Case Dimensions

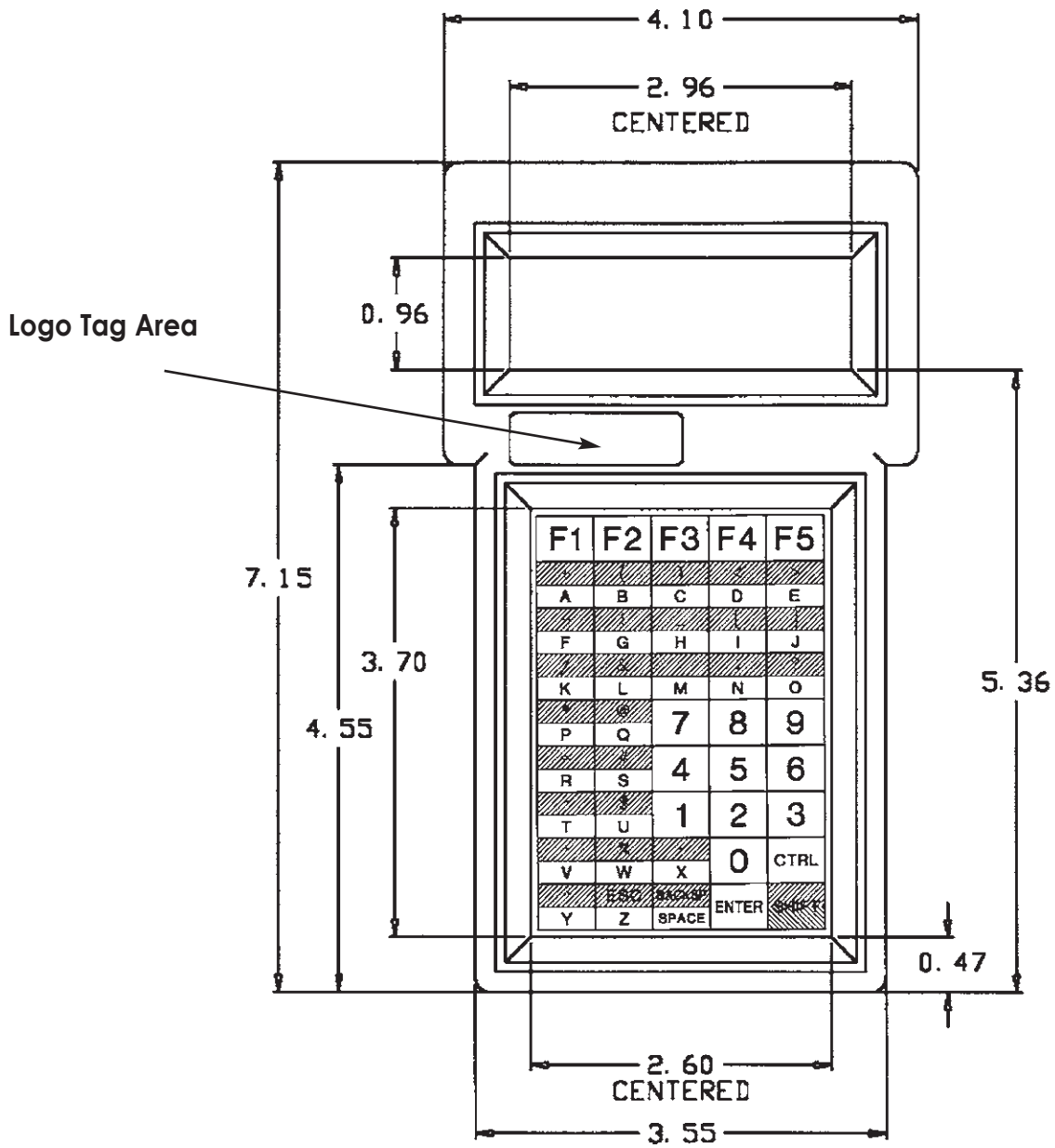
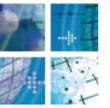

- Not Drawn to Scale
- All Dimensions are in Inches

# Layout Sample

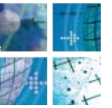

Draw in your logo and indicate the PANTONE® color(s).



Logo Tag

NOTE: Please provide us with camera-ready artwork if your corporate or product logo is required.

*NOTE: You don't need to be the next Leonardo da Vinci. Just pick-up a pen or a pencil and jot down your ideas. When you're happy with your layout, just fax it over. We have graphic designers who will turn your sketches into a masterpiece!*

## EXAMPLE:

Pantone Color(s):

1. *F1 = PMS 215*
2. *Text = Black*
3. *BKgrd = PMS Cool Gray 3*

Font & Point Size:

*Times New Roman 24 Pt.*

## EXAMPLE:

Pantone Color(s):

1. *Text = Black*
2. *BKgrd = PMS Cool Gray 3*

Font & Point Size:

*Times New Roman 24 Pt.*

Draw in your keypad and indicate the PANTONE® color(s).

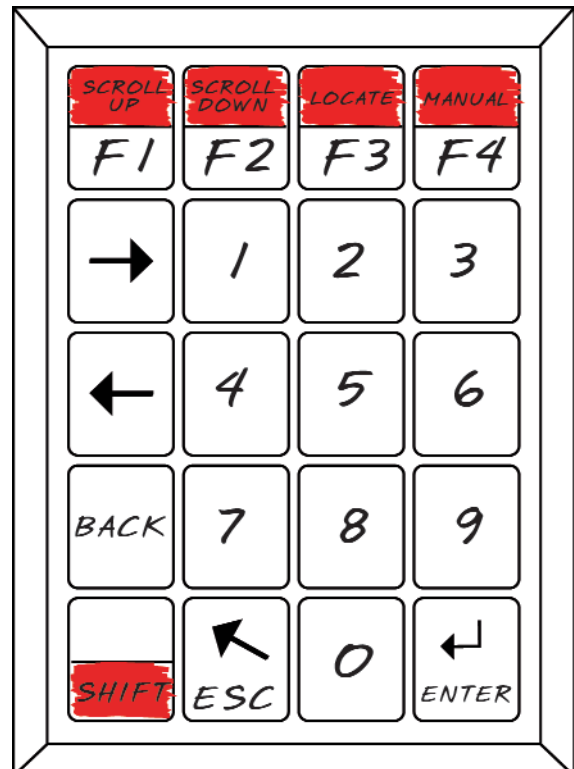

# Logo Tag Layouts

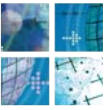

Line powered only

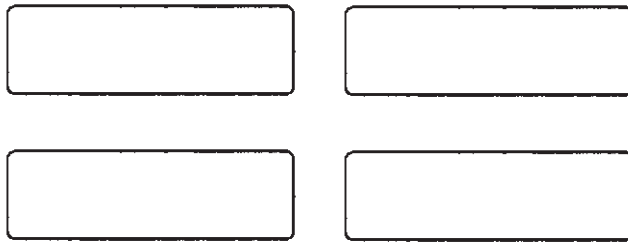

Scale 1:1

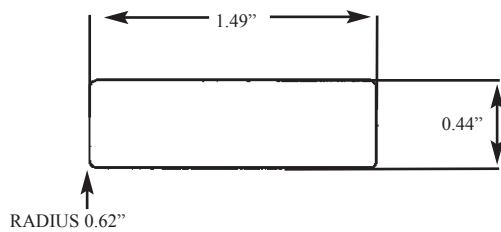

**Pantone Color(s):**

1. \_\_\_\_\_
2. \_\_\_\_\_
3. \_\_\_\_\_
4. \_\_\_\_\_
5. \_\_\_\_\_
6. \_\_\_\_\_

**Font & Point Size:**

\_\_\_\_\_

# On/Off Switch

Battery powered only

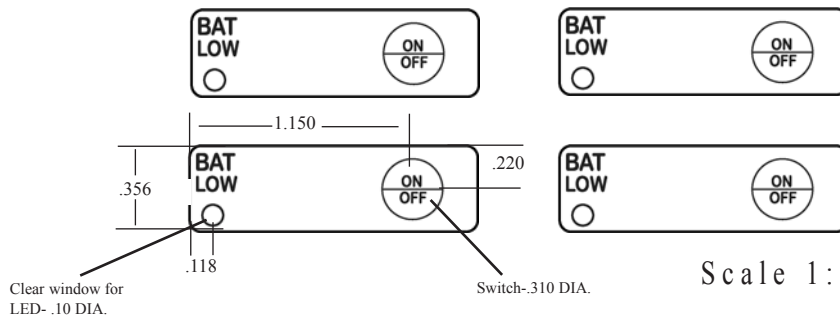

Scale 1:1

NOTE: LED's and switch are in a fixed location

**Pantone Color(s):**

1. \_\_\_\_\_
2. \_\_\_\_\_
3. \_\_\_\_\_
4. \_\_\_\_\_
5. \_\_\_\_\_
6. \_\_\_\_\_

**Font & Point Size:**

\_\_\_\_\_

**LED Label**

1. \_\_\_\_\_

**LED Label Pantone Color**

1. \_\_\_\_\_

# 15-Key Membrane

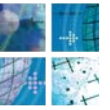

Scale 1:1

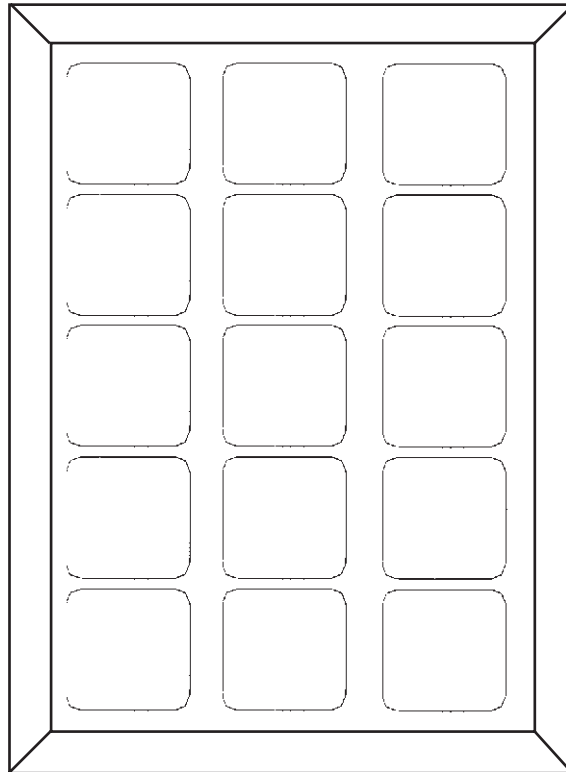

**Pantone Color(s):**

1. \_\_\_\_\_
2. \_\_\_\_\_
3. \_\_\_\_\_
4. \_\_\_\_\_
5. \_\_\_\_\_
6. \_\_\_\_\_

**Font & Point Size:**

\_\_\_\_\_

# 20-Key Membrane

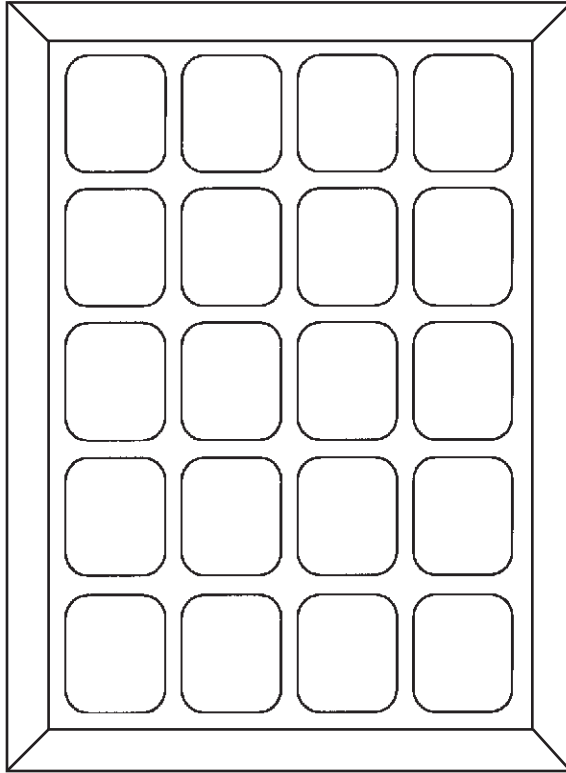
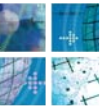

**Pantone Color(s):**

- 1. \_\_\_\_\_
- 2. \_\_\_\_\_
- 3. \_\_\_\_\_
- 4. \_\_\_\_\_
- 5. \_\_\_\_\_
- 6. \_\_\_\_\_

**Font & Point Size:**

\_\_\_\_\_

## 20-Key Elastomeric

**Pantone Color(s):**

- 1. \_\_\_\_\_
- 2. \_\_\_\_\_
- 3. \_\_\_\_\_
- 4. \_\_\_\_\_
- 5. \_\_\_\_\_
- 6. \_\_\_\_\_

**Font & Point Size:**

\_\_\_\_\_

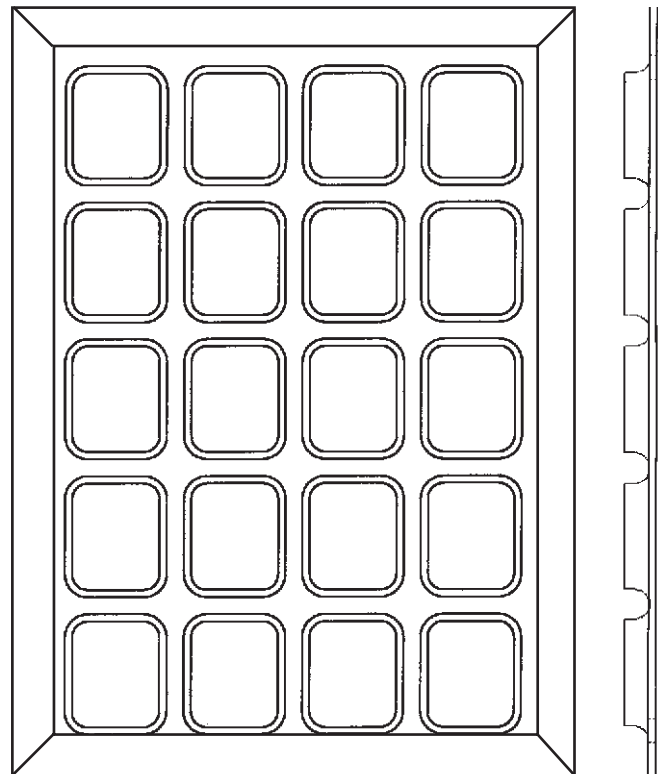

Scale 1:1

# 30-Key Membrane

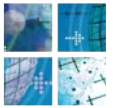

Scale 1:1

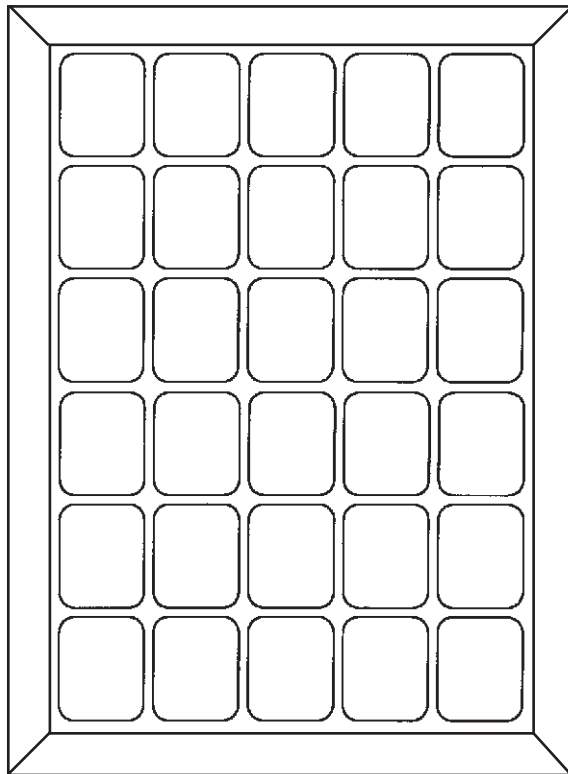

**Pantone Color(s):**

1. \_\_\_\_\_
2. \_\_\_\_\_
3. \_\_\_\_\_
4. \_\_\_\_\_
5. \_\_\_\_\_
6. \_\_\_\_\_

**Font & Point Size:**

\_\_\_\_\_

## 30-Key Elastomeric

Scale 1:1

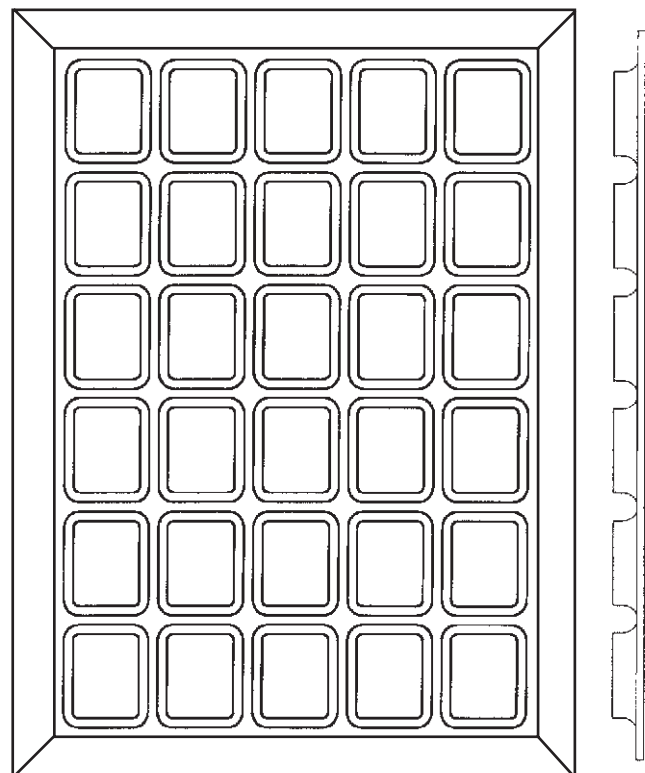

**Pantone Color(s):**

1. \_\_\_\_\_
2. \_\_\_\_\_
3. \_\_\_\_\_
4. \_\_\_\_\_
5. \_\_\_\_\_
6. \_\_\_\_\_

**Font & Point Size:**

\_\_\_\_\_



# 45-Key Membrane

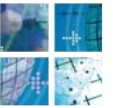

Scale 1:1

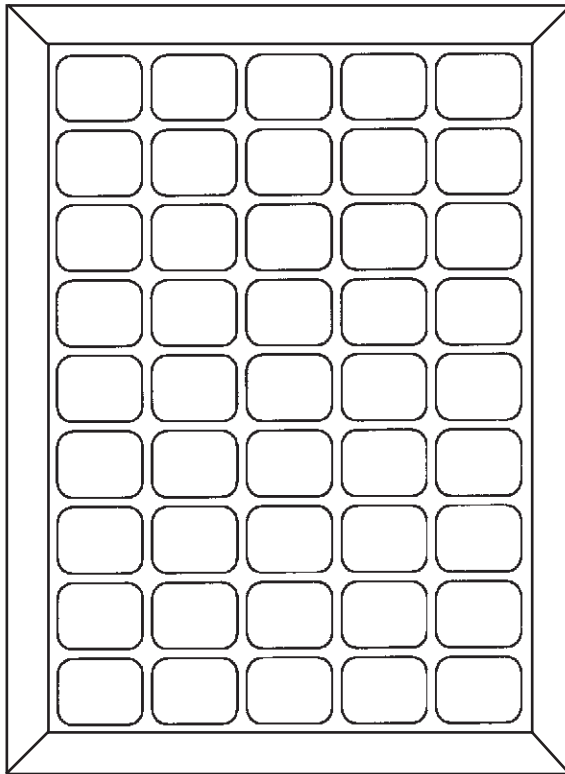

**Pantone Color(s):**

1. \_\_\_\_\_
2. \_\_\_\_\_
3. \_\_\_\_\_
4. \_\_\_\_\_
5. \_\_\_\_\_
6. \_\_\_\_\_

**Font & Point Size:**

\_\_\_\_\_

## 45-Key Elastomeric

**Pantone Color(s):**

1. \_\_\_\_\_
2. \_\_\_\_\_
3. \_\_\_\_\_
4. \_\_\_\_\_
5. \_\_\_\_\_
6. \_\_\_\_\_

**Font & Point Size:**

\_\_\_\_\_

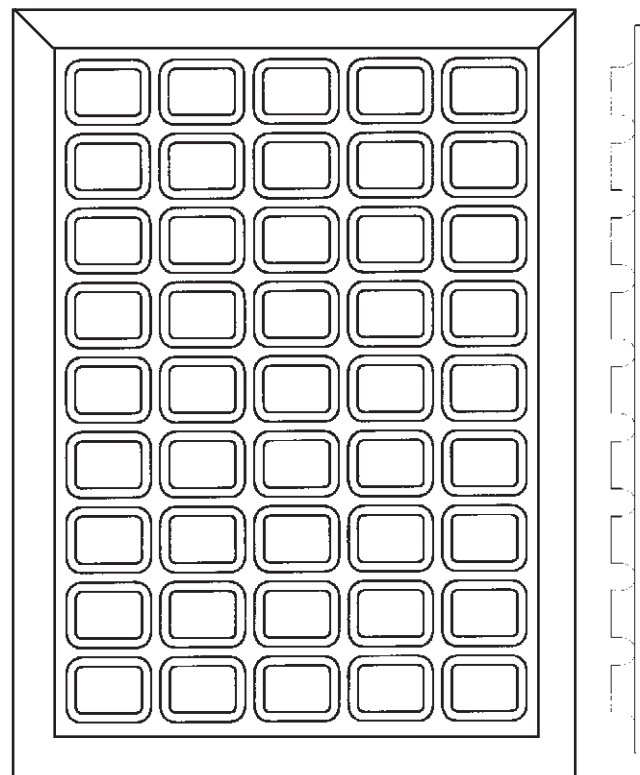

# Serial Tag Layout

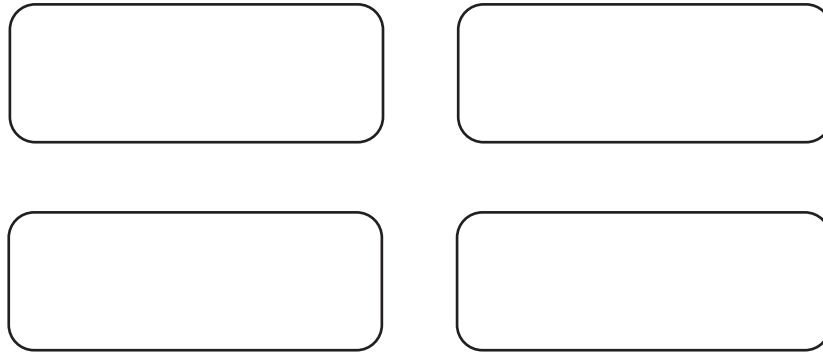
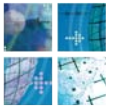

## Pantone Color(s):

1. \_\_\_\_\_
2. \_\_\_\_\_
3. \_\_\_\_\_
4. \_\_\_\_\_
5. \_\_\_\_\_
6. \_\_\_\_\_

## Font & Point Size:

\_\_\_\_\_

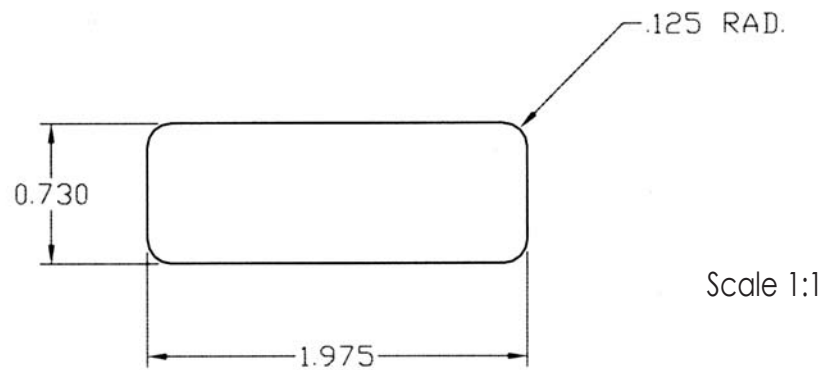

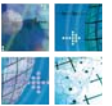

## Cable Types

- Straight Cable - Round Jacket     Straight Cable - Flat Jacket  
 Coiled Cable - Round Jacket     Coiled Cable - Flat Jacket

## Cable Length

- 7 Foot     15 Foot     Custom - Length= \_\_\_\_\_

## Cable Color

- Black     Gray  
 Other (Custom) \_\_\_\_\_

## Shielding

- Unshielded     Shielded  
Shield Termination at Host \_\_\_\_\_  
Shield Termination at Computer \_\_\_\_\_

## Wire Size

- 26GA (Std. for all cables)  
 Other (Custom) \_\_\_\_\_

## Custom Connector Information

Connector Type: \_\_\_\_\_

Connector Manufacturer: \_\_\_\_\_

Manufacturer Part No: \_\_\_\_\_

Qty: \_\_\_\_\_

- Sketch Attached     Sample Attached

# Connector Pin Outs (Line powered only)

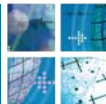

(Required at time of order)

RS-232

**Computer**

**YOUR CORRESPONDING PINS**

- 1 +Supply to Computer \_\_\_\_\_
- 2 Handshake into Computer \_\_\_\_\_
- 3 Handshake out from Computer \_\_\_\_\_
- 4 Data into Computer \_\_\_\_\_
- 5 Data out from Computer \_\_\_\_\_
- 6 Common \_\_\_\_\_

RS-422

**Computer**

**YOUR CORRESPONDING PINS**

- 1 +Supply to Computer \_\_\_\_\_
- 2 +Data into Computer \_\_\_\_\_
- 3 +Data out from Computer \_\_\_\_\_
- 4 -Data into Computer \_\_\_\_\_
- 5 -Data out from Computer \_\_\_\_\_
- 6 Common \_\_\_\_\_

RS-485

**Computer**

**YOUR CORRESPONDING PINS**

- 1 +Supply to Computer \_\_\_\_\_
- 2 Not Used \_\_\_\_\_
- 3 +Data \_\_\_\_\_
- 4 Not Used \_\_\_\_\_
- 5 -Data \_\_\_\_\_
- 6 Common \_\_\_\_\_